

Package leaflet: Information for the user

Xolair® 150 mg solution for injection in pre-filled pen **Xolair® 300 mg solution for injection in pre-filled pen** omalizumab

Read all of this leaflet carefully before you start using this medicine because it contains important information for you.

- Keep this leaflet. You may need to read it again.
- If you have any further questions, ask your doctor, pharmacist or nurse.
- This medicine has been prescribed for you only. Do not pass it on to others. It may harm them, even if their signs of illness are the same as yours.
- If you get any side effects, talk to your doctor, pharmacist or nurse. This includes any possible side effects not listed in this leaflet. See section 4.

What is in this leaflet

1. What Xolair is and what it is used for
2. What you need to know before you use Xolair
3. How to use Xolair
4. Possible side effects
5. How to store Xolair
6. Contents of the pack and other information

1. What Xolair is and what it is used for

Xolair contains the active substance omalizumab. Omalizumab is a man-made protein that is similar to natural proteins produced by the body. It belongs to a class of medicines called monoclonal antibodies.

Xolair is used for the treatment of:

- allergic asthma
- chronic rhinosinusitis (inflammation of the nose and sinuses) with nasal polyps
- chronic spontaneous urticaria (CSU)

Allergic asthma

This medicine is used to prevent asthma from getting worse by controlling symptoms of severe allergic asthma in adults, adolescents and children (6 years of age and older) who are already receiving asthma medicine, but whose asthma symptoms are not well controlled by medicines such as high-dose steroid inhalers and beta-agonist inhalers.

Chronic rhinosinusitis with nasal polyps

This medicine is used to treat chronic rhinosinusitis with nasal polyps in adults (18 years of age and older) who are already receiving intranasal corticosteroids (corticosteroid nasal spray), but whose symptoms are not well controlled by these medicines. Nasal polyps are small growths on the lining of the nose. Xolair helps to reduce the size of the polyps and improves symptoms including nasal congestion, loss of sense of smell, mucus in the back of the throat and runny nose.

Chronic spontaneous urticaria (CSU)

This medicine is used to treat chronic spontaneous urticaria in adults and adolescents (12 years of age and older) who are already receiving antihistamines but whose CSU symptoms are not well controlled by these medicines.

Xolair works by blocking a substance called immunoglobulin E (IgE), which is produced by the body. IgE contributes to a type of inflammation that plays a key role in causing allergic asthma, chronic rhinosinusitis with nasal polyps and CSU.

2. What you need to know before you use Xolair

Do not use Xolair:

- if you are allergic to omalizumab or any of the other ingredients of this medicine (listed in section 6).

If you think you may be allergic to any of the ingredients, tell your doctor as you should not use Xolair.

Warnings and precautions

Talk to your doctor before using Xolair:

- if you have kidney or liver problems.
- if you have a disorder where your own immune system attacks parts of your own body (autoimmune disease).
- if you are travelling to region where infections caused by parasites are common - Xolair may weaken your resistance to such infections.
- if you have had a previous severe allergic reaction (anaphylaxis), for example resulting from a medicine, an insect bite or food.

Xolair does not treat acute asthma symptoms, such as a sudden asthma attack. Therefore Xolair should not be used to treat such symptoms.

Xolair is not meant to prevent or treat other allergy-type conditions, such as sudden allergic reactions, hyperimmunoglobulin E syndrome (an inherited immune disorder), aspergillosis (a fungus-related lung disease), food allergy, eczema or hay fever because Xolair has not been studied in these conditions.

Look out for signs of allergic reactions and other serious side effects

Xolair can potentially cause serious side effects. You must look out for signs of these conditions while you use Xolair. Seek medical help immediately if you notice any signs indicating a severe allergic reaction or other serious side effects. Such signs are listed under “Serious side effects” in section 4.

It is important that you receive training from your doctor in how to recognise early symptoms of severe allergic reactions, and how to manage these reactions if they occur, before you inject Xolair yourself or before a non-healthcare professional gives you a Xolair injection (see section 3, “How to use Xolair”). The majority of severe allergic reactions occur within the first 3 doses of Xolair.

Children and adolescents

Allergic asthma

Xolair is not recommended for children under 6 years of age. Its use in children under 6 years of age has not been studied.

Chronic rhinosinusitis with nasal polyps

Xolair is not recommended for children and adolescents under 18 years of age. Its use in patients under 18 years of age has not been studied.

Chronic spontaneous urticaria (CSU)

Xolair is not recommended for children under 12 years of age. Its use in children under 12 years of age has not been studied.

Other medicines and Xolair

Tell your doctor, pharmacist or nurse if you are taking, have recently taken or might take any other medicines.

This is especially important if you are taking:

- medicines to treat an infection caused by a parasite, as Xolair may reduce the effect of your

- medicines,
- inhaled corticosteroids and other medicines for allergic asthma.

Pregnancy and breast-feeding

If you are pregnant, think you may be pregnant or are planning to have a baby, ask your doctor for advice before using this medicine. Your doctor will discuss with you the benefits and potential risks of using this medicine during pregnancy.

If you become pregnant while being treated with Xolair, tell your doctor immediately.

Xolair may pass into breast milk. If you are breast-feeding or plan to breast-feed, ask your doctor for advice before using this medicine.

Driving and using machines

It is unlikely that Xolair will affect your ability to drive and use machines.

3. How to use Xolair

Always use this medicine exactly as your doctor has told you. Check with your doctor, nurse or pharmacist if you are not sure

How Xolair is used

Xolair is used as an injection under your skin (known as a subcutaneous injection).

Injecting Xolair

- You and your doctor will decide if you should inject Xolair yourself. The first 3 doses are always given by or under the supervision of a healthcare professional (see section 2).
- It is important to be properly trained on how to inject the medicine before injecting yourself.
- A caregiver (for example a parent) may also give you your Xolair injection after he or she has received proper training.

For detailed instructions on how to inject Xolair, see “Instructions for use of Xolair pre-filled pen” at the end of this leaflet.

Training to recognise serious allergic reactions

It is also important that you do not inject Xolair yourself until you have been trained by your doctor or nurse on:

- how to recognise the early signs and symptoms of serious allergic reactions
- what to do if the symptoms occur.

For more information about the early signs and symptoms of serious allergic reactions, see section 4.

How much to use

Allergic asthma and chronic rhinosinusitis with nasal polyps

Your doctor will decide how much Xolair you need and how often you will need it. This depends on your body weight and the results of a blood test carried out before the start of the treatment to measure the amount of IgE in your blood.

You will need 1 to 3 injections at a time. You will need the injections either every two weeks, or every four weeks.

Keep taking your current asthma and/or nasal polyps medicine during Xolair treatment. Do not stop taking any asthma and/or nasal polyps medicine without talking to your doctor.

You may not see an immediate improvement after beginning Xolair treatment. In patients with nasal polyps effects have been seen 4 weeks after the start of the treatment. In asthma patients it usually

takes between 12 and 16 weeks to have the full effect.

Chronic spontaneous urticaria (CSU)

You will need two 150 mg injections at a time or one 300 mg injection every four weeks.

Keep taking your current medicine for CSU during Xolair treatment. Do not stop taking any medicine without talking to your doctor.

Use in children and adolescents

Allergic asthma

Xolair can be used in children and adolescents aged 6 years and older, who are already receiving asthma medicine, but whose asthma symptoms are not well controlled by medicines such as high dose steroid inhalers and beta-agonist inhalers. Your doctor will work out how much Xolair your child needs and how often it needs to be given. This will depend on your child's weight and the results of a blood test carried out before the start of the treatment to measure the amount of IgE in his/her blood.

Children (6 to 11 years of age) are not expected to self-administer Xolair. However, if considered appropriate by their doctor, a caregiver may give them their Xolair injection after proper training.

Xolair pre-filled pens are not intended for use in children under 12 years of age. Xolair 75 mg pre-filled syringe and Xolair 150 mg pre-filled syringe or Xolair powder and solvent for solution for injection may be used in children 6-11 years of age with allergic asthma.

Chronic rhinosinusitis with nasal polyps

Xolair should not be used in children and adolescents under 18 years of age.

Chronic spontaneous urticaria (CSU)

Xolair can be used in adolescents aged 12 years of age and older, who are already receiving antihistamines but whose CSU symptoms are not well controlled by these medicines. The dose for adolescents aged 12 years and above is the same as for adults.

If a dose of Xolair is missed

If you have missed an appointment, contact your doctor or hospital as soon as possible to re-schedule it.

If you have forgotten to give yourself a dose of Xolair, inject the dose as soon as you remember. Then talk to your doctor to discuss when you should inject the next dose.

If you stop treatment with Xolair

Do not stop treatment with Xolair unless your doctor tells you to. Interrupting or stopping the treatment with Xolair may cause your symptoms to come back.

However, if you are being treated for CSU, your doctor may stop Xolair treatment from time to time so that your symptoms can be assessed. Follow your doctor's instructions.

If you have any further questions on the use of this medicine, ask your doctor, pharmacist or nurse.

4. Possible side effects

Like all medicines, this medicine can cause side effects, although not everybody gets them. The side effects caused by Xolair are usually mild to moderate but can occasionally be serious.

Serious side effects:

Seek medical attention immediately if you notice any signs of the following side effects:

Rare (may affect up to 1 in 1 000 people)

- Severe allergic reactions (including anaphylaxis). Symptoms may include rash, itching or hives on the skin, swelling of the face, lips, tongue, larynx (voice box), windpipe or other parts of the body, fast heartbeat, dizziness and light-headedness, confusion, shortness of breath, wheezing or trouble breathing, blue skin or lips, collapsing and losing consciousness. If you have a history of severe allergic reactions (anaphylaxis) unrelated to Xolair you may be more at risk of developing a severe allergic reaction following use of Xolair.
- Systemic lupus erythematosus (SLE). Symptoms may include muscle pain, joint pain and swelling, rash, fever, weight loss, and fatigue.

Not known (frequency cannot be estimated from the available data)

- Churg-Strauss syndrome or hypereosinophilic syndrome. Symptoms may include one or more of the following: swelling, pain or rash around blood or lymph vessels, high level of a specific type of white blood cells (marked eosinophilia), worsening problems with breathing, nasal congestion, heart problems, pain, numbness, tingling in the arms and legs.
- Low blood platelet count with symptoms such as bleeding or bruising more easily than normal.
- Serum sickness. Symptoms may include one or more of the following: joint pain with or without swelling or stiffness, rash, fever, swollen lymph nodes, muscle pain.

Other side effects include:

Very common (may affect more than 1 in 10 people)

- fever (in children)

Common (may affect up to 1 in 10 people)

- reactions at the injection site including pain, swelling, itching and redness
- pain in the upper part of the tummy
- headache (very common in children)
- upper respiratory tract infection, such as inflammation of the pharynx and common cold
- feeling of pressure or pain in the cheeks and forehead (sinusitis, sinus headache)
- pain in joints (arthralgia)
- feeling dizzy

Uncommon (may affect up to 1 in 100 people)

- feeling sleepy or tired
- tingling or numbness of the hands or feet
- fainting, low blood pressure while sitting or standing (postural hypotension), flushing
- sore throat, coughing, acute breathing problems
- feeling sick (nausea), diarrhoea, indigestion
- itching, hives, rash, increased sensitivity of the skin to sun
- weight increase
- flu-like symptoms
- swelling arms

Rare (may affect up to 1 in 1 000 people)

- parasitic infection

Not known (frequency cannot be estimated from the available data)

- muscle pain and joint swelling
- hair loss

Reporting of side effects

If you get any side effects, talk to your doctor, pharmacist or nurse. This includes any possible side effects not listed in this leaflet. You can also report side effects directly via the Yellow Card Scheme

at: www.mhra.gov.uk/yellowcard or search for MHRA Yellow Card in the Google Play or Apple App Store. By reporting side effects you can help provide more information on the safety of this medicine.

5. How to store Xolair

- Keep this medicine out of the sight and reach of children.
- Do not use this medicine after the expiry date which is stated on the label after EXP. The expiry date refers to the last day of that month. The carton containing the pre-filled pen can be stored for a total time of 48 hours at room temperature (25°C) before use.
- Store in the original package in order to protect from light.
- Store in a refrigerator (2°C – 8°C). Do not freeze.
- Do not use any pack that is damaged or shows signs of tampering.

6. Contents of the pack and other information

What Xolair contains

- The active substance is omalizumab.
 - One pen of 1 ml solution contains 150 mg omalizumab.
 - One pen of 2 ml solution contains 300 mg omalizumab.
- The other ingredients are arginine hydrochloride, histidine hydrochloride monohydrate, histidine, Polysorbate 20 and water for injections.

What Xolair looks like and contents of the pack

Xolair solution for injection is supplied as a clear to slightly opalescent, colourless to pale brownish-yellow solution in a pre-filled pen.

Xolair 150 mg solution for injection in pre-filled pen is supplied in packs containing 1 pre-filled pen, and in multipacks containing 3 (3 x 1) or 6 (6 x 1) pre-filled pens.

Xolair 300 mg solution for injection in pre-filled pen is supplied in packs containing 1 pre-filled pen, and in multipacks containing 3 (3 x 1) or 6 (6 x 1) pre-filled pens.

Not all pack sizes may be marketed.

Marketing Authorisation Holder and Manufacturer

Novartis Pharmaceuticals UK Limited
2nd Floor, The WestWorks Building, White City Place
195 Wood Lane
London
W12 7FQ
United Kingdom

For any information about this medicine, please contact the local representative of the Marketing Authorisation Holder:

United Kingdom

Novartis Pharmaceuticals UK Ltd.
Tel: +44 1276 698370

This leaflet was last revised in March 2024.

INSTRUCTIONS FOR USE OF XOLAIR PRE-FILLED PEN

These “Instructions for Use” contain information on how to inject Xolair.

If your doctor decides that you or your caregiver may be able to give your injections of Xolair at home, ensure that your doctor or nurse shows you or your caregiver how to prepare and inject with the Xolair pen before you use it for the first time.

This Xolair pen is intended to be used for patients ages 12 and up.

Be sure that you read and understand these “Instructions for Use” before injecting with the Xolair pen. Talk to your doctor if you have any questions.

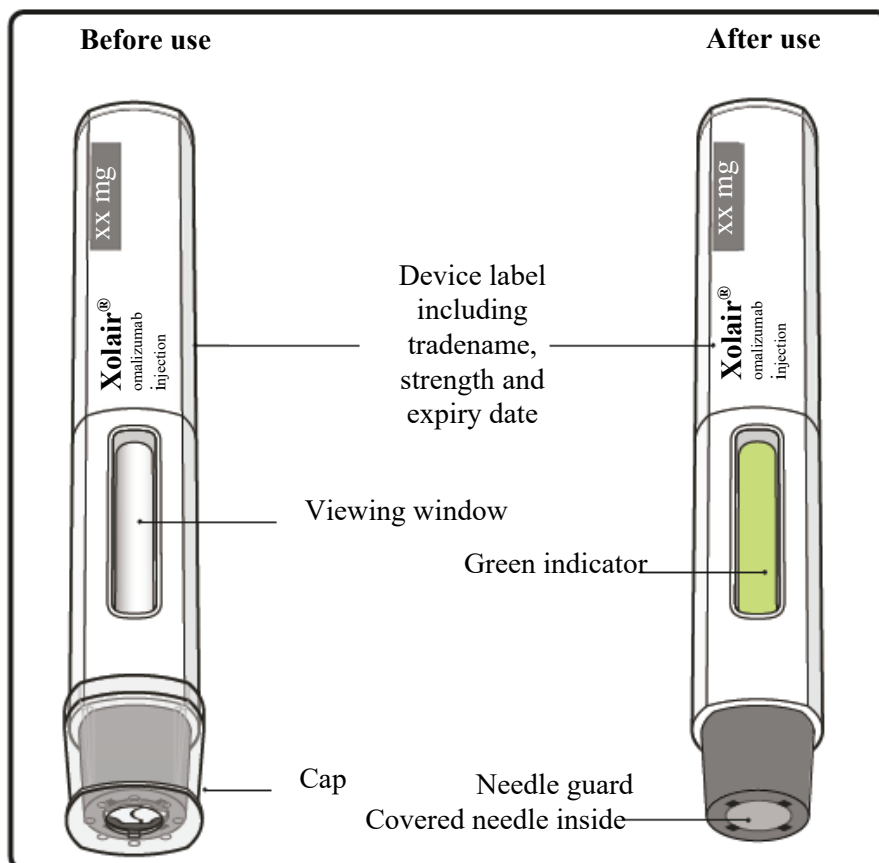

Important information you need to know before injecting Xolair

- Xolair is for subcutaneous injection only (inject directly into fatty layer under the skin).
- **Do not** use the pen if the seal on the outer carton is broken.
- **Do not** use if the pen has been dropped after removing the cap.
- **Do not** inject if the pen has been kept out of the refrigerator for more than a total of 48 hours. Dispose of it (see Step 13) and use a new pen for your injection.
- **Do not** touch or push the needle guard as you could get injured. Touching or pushing on the needle guard could cause a needlestick injury.
- **Do not** try to re-use or take apart the pen.
- **Do not** try to reattach the cap once it has been taken off.

Store Xolair











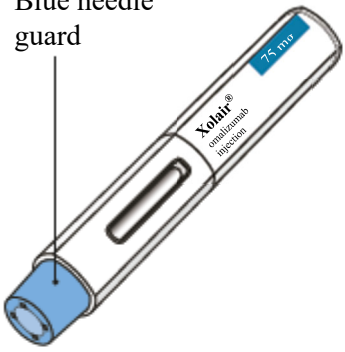
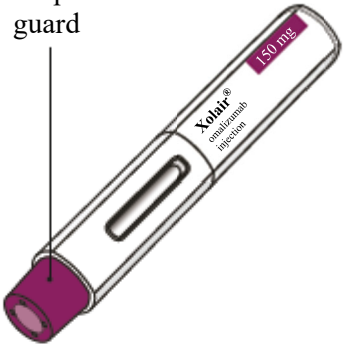
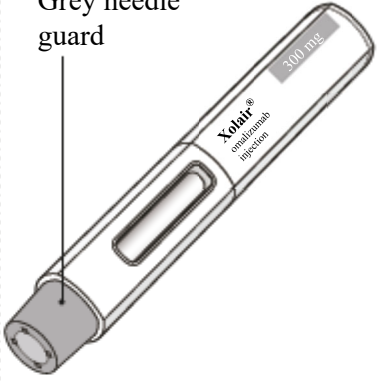



- Store in a refrigerator (2°C - 8°C). The carton containing the pen can be stored for a total time of 48 hours at room temperature (25°C) before use.
- **Do not** freeze.
- Keep the pen in the original carton until ready to use in order to protect from light.
- Keep the pen out of sight and reach of children.

DOSING TABLE

Xolair pens are available in 3 dose strengths (one pen in each carton). These instructions are to be used for all 3 dose strengths.

Depending on the dose prescribed to you by your doctor, you may need to select one or more pens, and inject the contents of them all in order to deliver your full dose. The Dosing Table below shows the combination of pens needed to deliver your full dose.

Contact your doctor if you have questions on the Dosing Table.

		Xolair 75 mg pen with a blue needle guard	Xolair 150 mg pen with a purple needle guard	Xolair 300 mg pen with a grey needle guard
		<p>Blue needle guard</p> 	<p>Purple needle guard</p> 	<p>Grey needle guard</p> 
Dose	Number of pens needed for the dose	Blue 75 mg	Purple 150 mg	Grey 300 mg
75 mg	1 blue			
150 mg	1 purple			
225 mg	1 blue + 1 purple			
300 mg	1 grey			
375 mg	1 blue + 1 grey			
450 mg	1 purple + 1 grey			
525 mg	1 blue + 1 purple + 1 grey			
600 mg	1 grey + 1 grey			

Prepare to inject Xolair

Step 1. Bring to room temperature

Take the carton containing the pen out of the refrigerator **and leave it unopened so that it reaches room temperature (minimum 30 minutes)**.

Note: If you need more than one pen (one pen in each carton) to deliver your full dose (see Dosing Table), take all the cartons out of the refrigerator at the same time.

Step 2. Gather supplies

You will need the following supplies (not included in the carton):

- Alcohol wipe
- Cotton ball or gauze pad
- Sharps disposal container
- Adhesive plaster

Step 3. Unpack

Take the pen out of the outer carton.

Do not remove the cap until you are ready to inject.

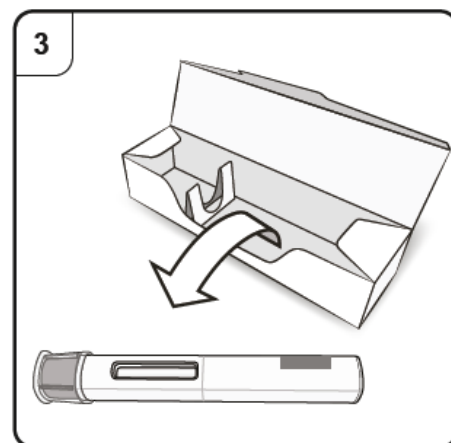

Step 4. Inspect the pen

Look through the viewing window of the pen. The liquid inside should be clear to slightly cloudy. Its colour may vary from colourless to pale brownish-yellow. You may see air bubbles in the liquid, which is normal.

- **Do not** use the pen if the liquid contains particles, or if the liquid looks distinctly cloudy or distinctly brown.
- **Do not** use the pen if it looks damaged.
- **Do not** use the pen after the expiry date (EXP), which is printed on the pen label and carton.

In all of these cases, contact your doctor, nurse or pharmacist.

Step 5. Choose injection site

You should inject into the front of the thighs or the lower stomach area but not the area 5 cm around the belly button.

Do not inject into skin that is tender, bruised, red, scaly or hard or into areas with scars or stretch marks.

Note: If you need more than one pen to deliver your full dose, make sure your injections are at least 2 cm apart.

If a caregiver, doctor or nurse is giving the injection, they may also inject into the outer upper arm.

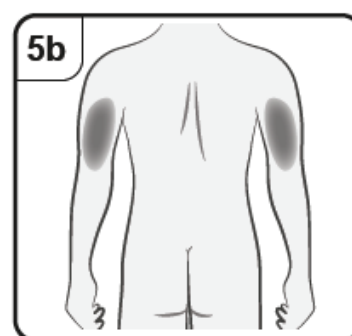
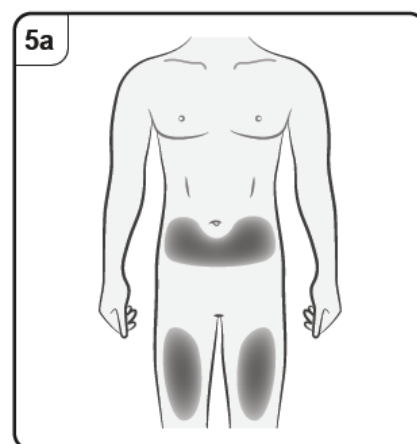
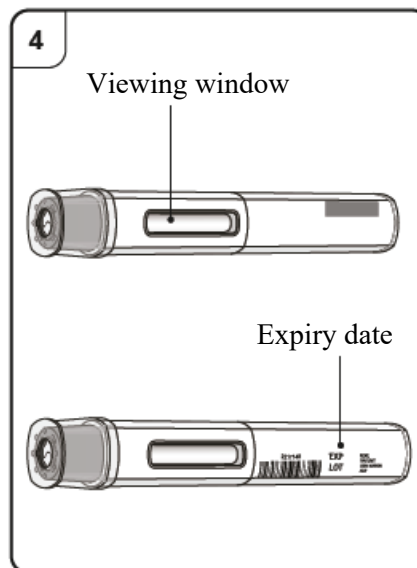

Inject with Xolair

Step 6. Clean injection site

Clean your hands.

Clean the chosen injection site with an alcohol wipe. Leave it to dry before injecting.

Do not touch or blow on the cleaned skin before injecting.

Step 7. Remove cap

Pull the cap straight off in the direction of the arrow.

Do not put the cap back on. Throw away the cap.

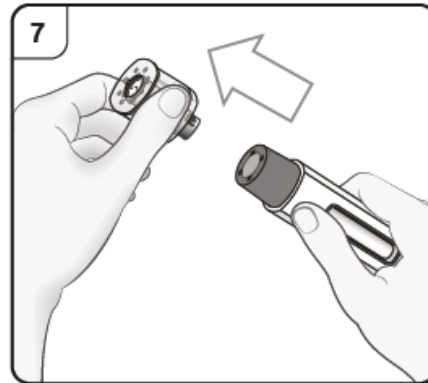

Step 8. Position the pen

Hold the pen comfortably **with the needle guard directly against the skin**.

The pen should be at a 90° angle to the skin as shown.

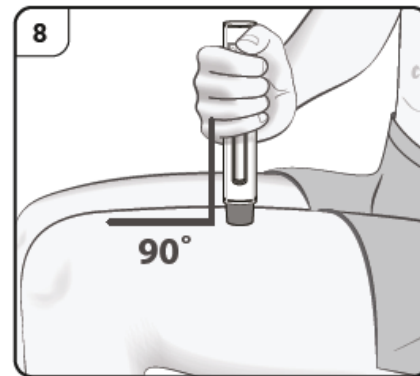

Step 9. Start injection

Push and hold the pen firmly against the skin. Listen for the **1st click** which indicates that the injection has started.

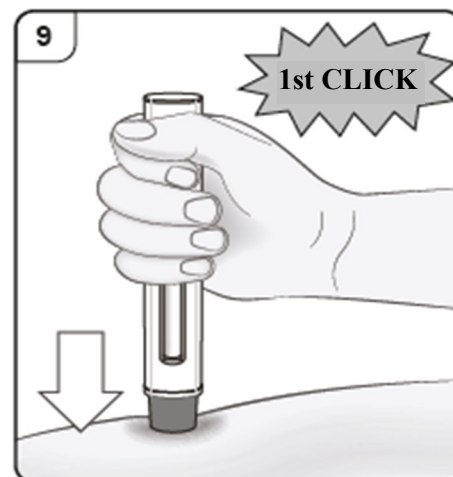

Step 10. Monitor injection

Keep holding the pen firmly down against the skin. The green indicator shows the progress of the injection.

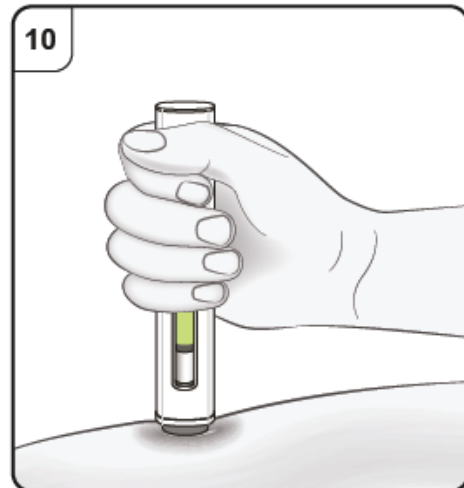

Step 11. Complete injection

Listen for the **2nd click**. This indicates the injection is **almost** complete.

Keep holding the pen in position until the green indicator has stopped moving to make sure the injection is complete. Remove the pen from the skin. The needle is automatically covered by the needle guard. The injection is now complete.

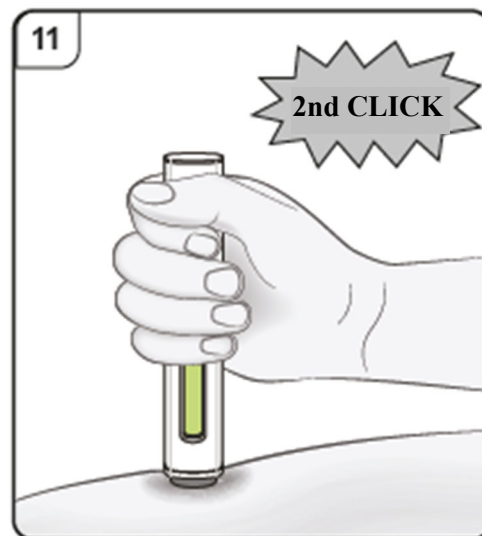

After the injection

Step 12. Check green indicator

If the green indicator has not completely filled the viewing window, contact your doctor or nurse.

There may be a small amount of blood at the injection site.

You can press a cotton ball or gauze pad over the injection site until any bleeding stops.

Do not rub the injection site. If needed, cover your injection site with a small adhesive plaster.

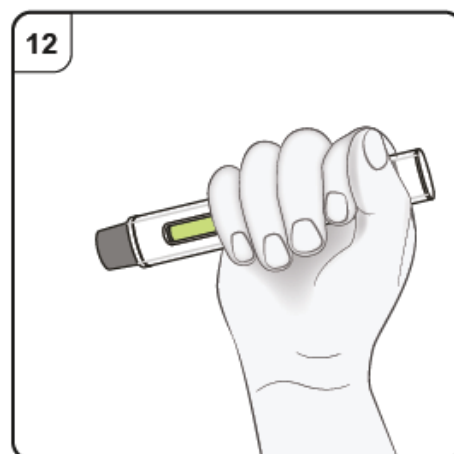

Note: If you need more than one pen to deliver your full dose, throw away the used pen as described in Step 13.

Repeat Step 2 to Step 13 again for all the pens needed to deliver your full dose.

Carry out the injections immediately one after another.

Make sure the injections are at least 2 cm apart.

Step 13. Dispose of the pen

Put the used pen in a sharps disposal container (i.e. a puncture-resistant closable container, or similar) right away after use.

Talk to your doctor or pharmacist about proper disposal of the sharps disposal container. There may be local regulations for disposal.