

Instructions for Use

Noxafil 300 mg gastro-resistant powder and solvent for oral suspension posaconazole

Instructions for Use for caregivers of toddlers and children

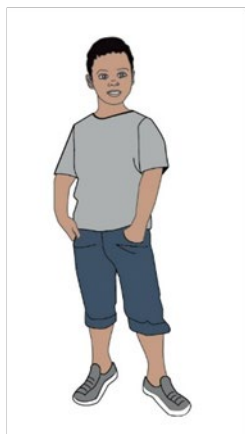

- **Make sure you read and understand these instructions for use.**
- **Bring this booklet to your child's appointments.**

Before you start

- Before you start, make sure that you read and understand all of these instructions. They may be different than those for medicines that you have used in the past.
- It is important that you make all measurements very carefully.
- Before you give Noxafil, check all 3 expiry dates. The expiry date is printed on the box (Figure 1), the Noxafil sachets (Figure 2), and the solvent (Figure 3).
- Do not open the Noxafil sachets until you are ready to mix the dose.



Figure 1

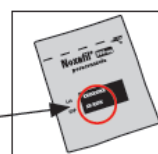

Figure 2



Figure 3

Note: If you have any questions, talk to your doctor or pharmacist.





Before you start

- The amount of Noxafil you give depends on your child's weight. Your doctor will tell you the right dose to give your child. Make sure to keep your doctor's appointments so you get new dosing information as your child grows.
- This booklet tells you how to:
 - Make the Noxafil into a liquid form
 - Measure the right dose using an oral syringe
 - Give the Noxafil to your child
 - Clean up

Note: Put your child in a safe place. You will need both hands to prepare Noxafil. Wash your hands with soap and water before preparing Noxafil.

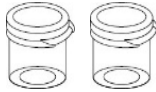
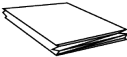
Note before adding Noxafil: Make sure you and your child are ready. If you do not use Noxafil within **30 minutes**, you will need to throw it away and start over.

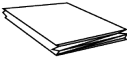
Kit Contents

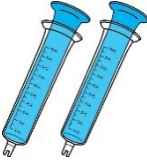
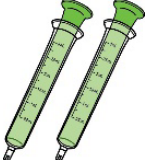
- Outer carton 
- 2 mixing cups 
- Instructions for use (this booklet) 
- 8 sachets of Noxafil powder 
- Package leaflet 
- Bottle adapter 
- 4 syringes (shown below) 
- 2 blue (10 mL) syringes 
- 2 green (3 mL) syringes 

The kit has an extra cup and set of syringes in case one is lost or damaged. Do not use any damaged cups or syringes.

Get to Know the Oral Syringes

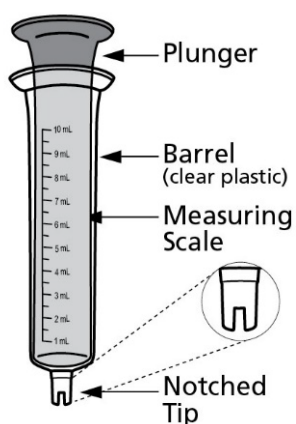

- Before you prepare a dose, review the parts of the syringe and how to use them.
 - If you have any questions about measuring with a syringe, talk to your doctor or pharmacist.
 - Make sure the plunger is pushed all the way into the barrel before you start to measure the dose.
-
- Look for the number on the measuring scale that matches the amount of solvent or Noxafil that you need.
 - Make sure to follow the directions in this booklet to remove air bubbles from the syringe. **Air bubbles can affect the amount of medicine that the child gets.**

Step 1. Get the solvent ready

Note: Noxafil needs to be prepared using the solvent.

Do not mix Noxafil with milk, juice, or water.



When you use the solvent for the first time:

- Open the bottle and remove the safety seal. Use scissors if needed.
- Place the bottle adapter on top of the bottle with the small hole facing up.
- **Push the bottle adapter all the way down.**
- Once in place, the bottle adapter stays in the bottle.
- Put the cap back on the bottle.

Step 2. Gather all your supplies and put on a clean surface

Note: Put your child in a safe place. You will need both hands to prepare Noxafil. Wash your hands with soap and water before preparing Noxafil.



1 mixing cup
(Using the tab on the mixing cup, pull open the lid.)



1 sachet of Noxafil powder



Solvent

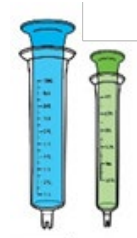

1 blue syringe and 1 green syringe
(Have 1 of each ready, but you may only use 1, depending on the dose.)



Scissors
(not included with kit: use sharp household or kitchen scissors)

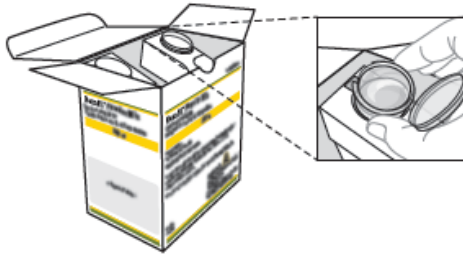

The Noxafil box has a mixing cup holder inside to help tilt the cup when you are measuring the dose.

Step 3. Add Noxafil to the mixing cup

Note before adding Noxafil:

Make sure you and your child are ready. If you do not use Noxafil within **30 minutes**, you will need to throw it away and start over.

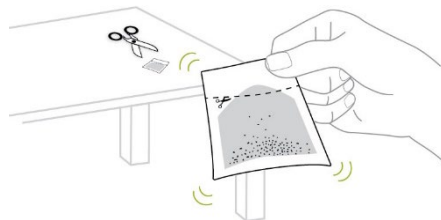

Figure 1

- Take **1 sachet** of Noxafil and shake the powder to the bottom of the sachet. (Figure 1)

- Cut open the sachet at the dotted line and add all of the powder to the mixing cup. Make sure the sachet is completely empty. (Figure 2)

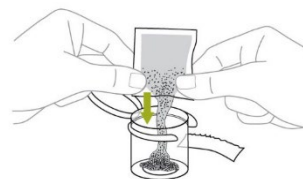

Figure 2

Step 4. Shake the solvent bottle



- Shake the solvent well before each time you prepare Noxafil.

Step 5. Fill the blue syringe with 9 mL of solvent

- Push the plunger of the **blue** syringe into the syringe barrel as far as it goes.
- Remove the cap from the bottle of solvent.
- Push the notched tip of the syringe into the bottle adapter.
- With the syringe attached to the bottle, turn the bottle and syringe upside down. With your other hand, pull back the plunger to draw the solvent back into the syringe.
- Stop when you get to the 9 mL line.
- Turn the bottle back over and remove the syringe to check your measurement.

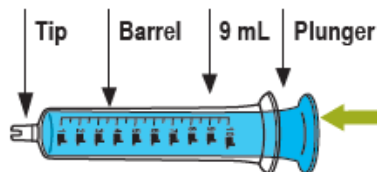

Step 6. Check for air bubbles

- Hold the syringe with notched tip up. Tap it with your finger to move any air bubbles.
- Slowly push the plunger to make the air come out. (Figure 1)

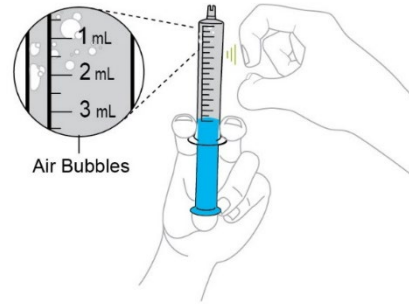
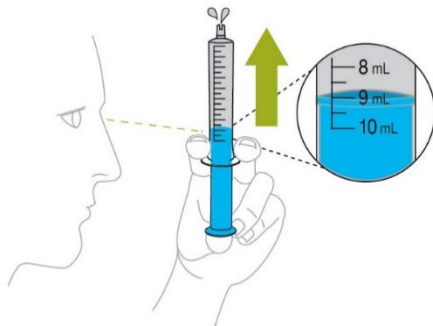

Figure 1



- Re-check the measurement of the solvent in the syringe. If it is less than 9 mL, put the notched tip back into the solvent and pull the plunger back until you get to the 9 mL mark. (Figure 2)

Figure 2

Step 7. Add the 9 mL of solvent to the Noxafil

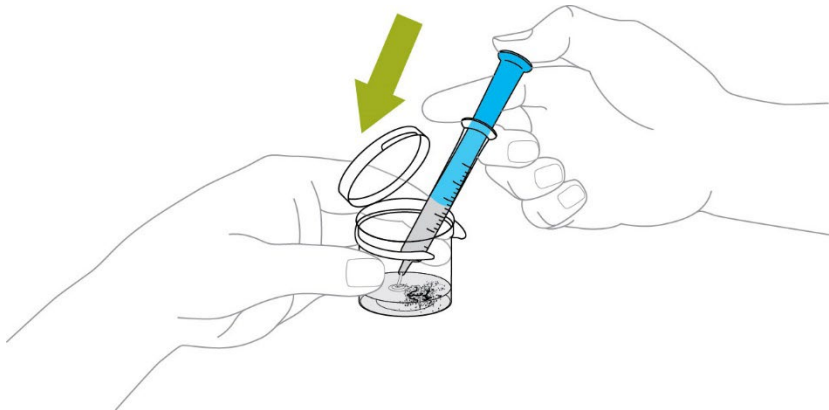

- Add the 9 mL of solvent to the Noxafil powder in the mixing cup by pushing all the way down on the plunger.

Step 8. Mix the Noxafil

- Snap the lid of the mixing cup shut.
- Shake the mixing cup really hard for 45 seconds to mix the Noxafil. (Figure 1)

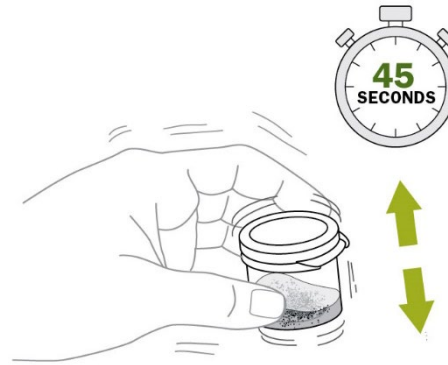
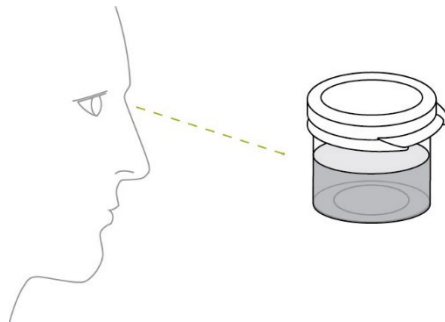

Figure 1



- Check to make sure the powder is mixed. If it is not mixed, shake the mixing cup some more. Noxafil should look cloudy and free of clumps. (Figure 2)

Figure 2

Step 9. Check your prescription

- Use the dose amount in 'mL' prescribed by the doctor.

Note: The dose may change each time you go to the doctor, so make sure you have all the recent information. Be sure to go to all of your child's doctor appointments so your child gets the right dose.

Step 10. Choose the syringe you need

Note: Only use the syringes provided in the kit.

Choose the correct syringe for your child's dose:

For 1 mL
to 3 mL
Green

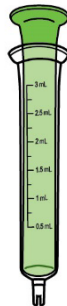

For 3 mL
to 10 mL
Blue

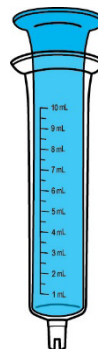

- Then find the mL mark on the syringe that matches your child's dose.

Step 11. Measure the Noxafil

- Push the plunger into the dosing syringe as far as it goes. (Figure 1)
- Tilt the cup by hand or use the mixing cup holder inside the Noxafil box. (Figure 2)
- Put the notched tip of the dosing syringe into the lowest part of the cup with the Noxafil and pull back the plunger. (Figure 3)
- Stop when you get to the line showing the prescribed dose.

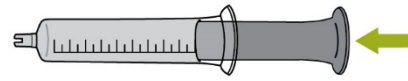

Figure 1

Figure 2

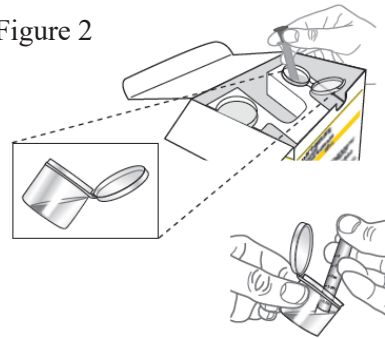

Figure 3

Note: You will not use all of the Noxafil. There will be some left over in the mixing cup.

Step 12. Check for air bubbles

- Hold the syringe with notched tip up. Tap it with your finger to move any air bubbles.
- Slowly push the plunger to make the air come out. (Figure 1)

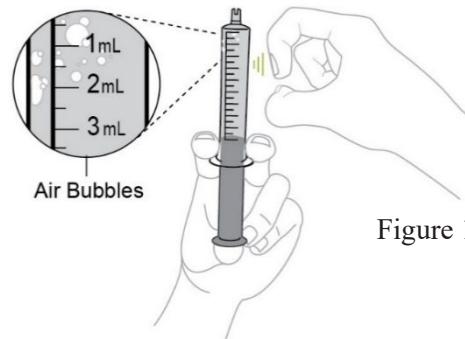

Figure 1

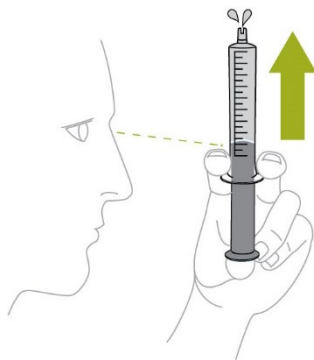

Figure 2

- Re-check the measurement of Noxafil in the syringe. If it is less than the prescribed dose, put the notched tip back into the mixing cup with the Noxafil and pull the plunger back until you get to the right dose mark. (Figure 2)

Step 13. Give the Noxafil to your child

- Gently place the syringe inside your child's mouth so that the notched tip touches the inside of their cheek.
- Slowly push down on the plunger to give the dose of Noxafil. It is important that your child takes all of the dose (a little left in the syringe notched tip is ok).



Note:

- If your child vomits or spits out the whole dose within 15 minutes of taking Noxafil, a dose may be repeated once. Follow-up your doctor or pharmacist if this occurs.
- Only use the solvent from the kit. Do not mix Noxafil with milk, juice, or water.

Step 14. Clean the cup and syringes

Note: Syringes and mixing cups should be reused. Do not throw away syringes and mixing cups provided until all the Noxafil sachets are used. If syringes cannot be washed and reused, additional syringes are provided in pack 2.

- Pour the leftover Noxafil from the mixing cup into the household waste bin.
Do not pour it into the sink.
- Pull the plungers out of any syringes you used.
- Hand wash the syringes, plungers, and mixing cup with warm water and washing-up liquid. **Do not wash in the dishwasher.**
- Rinse with water and air dry.
- Put everything in a clean, dry place.

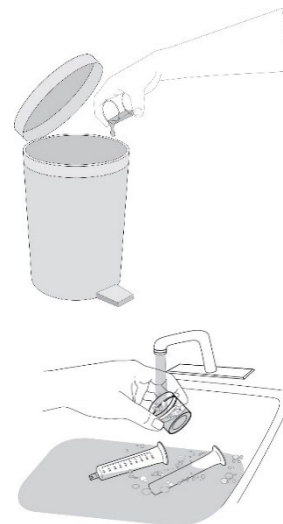

Step 15. After all sachets of Noxafil have been used

- After you have used the last Noxafil sachet in this box, you will have leftover solvent in the bottle. Throw away the leftover solvent and all components of the kit.

This instructions for use was last revised in November 2021

© 2022 Merck & Co., Inc., Rahway, NJ, USA and its affiliates. All rights reserved.

IFU.NOX.PFS.21.GB-NI.7989.II-006.RCN022112